

# **S2R72A Series LSI Evaluation Board Manual**

## NOTICE

---

No part of this material may be reproduced or duplicated in any form or by any means without the written permission of Seiko Epson. Seiko Epson reserves the right to make changes to this material without notice. Seiko Epson does not assume any liability of any kind arising out of any inaccuracies contained in this material or due to its application or use in any product or circuit and, further, there is no representation that this material is applicable to products requiring high level reliability, such as, medical products. Moreover, no license to any intellectual property rights is granted by implication or otherwise, and there is no representation or warranty that anything made in accordance with this material will be free from any patent or copyright infringement of a third party. This material or portions thereof may contain technology or the subject relating to strategic products under the control of the Foreign Exchange and Foreign Trade Law of Japan and may require an export license from the Ministry of Economy, Trade and Industry or other approval from another government agency.

All brands or product names mentioned herein are trademarks and/or registered trademarks of their respective companies.

## **Scope**

This document applies to the S2R72A04 EVA BOARD RoHS (Product code S5U2R72A04F0100) evaluation board for the S2R72A04 hub control LSI supporting USB 2.0 (Product code S2R72A44F12C400 / S2R72A43F12C400 / S2R72A42F12C400).

# Table of Contents

<b>1. Overview</b> .....	<b>1</b>
<b>2. Connectors, LEDs, and Power Supply</b> .....	<b>2</b>
2.1 Connectors .....	2
2.2 LEDs .....	2
2.3 Power Supply .....	3
<b>3. Function Settings</b> .....	<b>4</b>
3.1 Jumper pin list .....	4
3.2 Mode settings .....	5
<b>4. S2R72A43/S2R72A42</b> .....	<b>6</b>
<b>5. Appendix</b> .....	<b>7</b>
5.1 External dimension diagram .....	7
5.2 Circuit diagram .....	7
5.3 Parts list .....	8
<b>Revision History</b> .....	<b>11</b>



### 1. Overview

This document explains how to use the S2R72A04 EVA BOARD RoHS (product code: S5U2R72A04F0100).

## 2. Connectors, LEDs, and Power Supply

---

## 2. Connectors, LEDs, and Power Supply

### 2.1 Connectors

The connector uses are as shown below.

Ref.	Use
CN1	Power supply input (5 V)
CN2	Power supply input (3.3/1.8 V) (Note)
CN3	USB upstream port
CN4	Function expansion
CN5	USB downstream port 4
CN6	USB downstream port 3
CN7	USB downstream port 2
CN8	USB downstream port 1

Note: Not used when onboard regulator is used.

### 2.2 LEDs

The LED illumination patterns are as shown below.

Ref.	Illumination pattern
LED1	Illuminates when 5 V power supply is input.
LED2	Illuminates when PORT4 VBUS switch (IC5) is on.
LED3	Illuminates when PORT3 VBUS switch (IC6) is on.
LED4	Illuminates when PORT2 VBUS switch (IC7) is on.
LED5	Illuminates when PORT1 VBUS switch (IC8) is on.

### 2.3 Power Supply

The diagram below illustrates the power supply configuration for the evaluation board. Provide +5 V to CN1. CN2 is not used.

Note that, if +3.3 V and +1.8 V external power supplies are provided, +5 V should be input to CN1, and +3.3 V and +1.8 V should be input to CN2. In this case, JP1 and JP2 described later must be changed from their default factory settings.

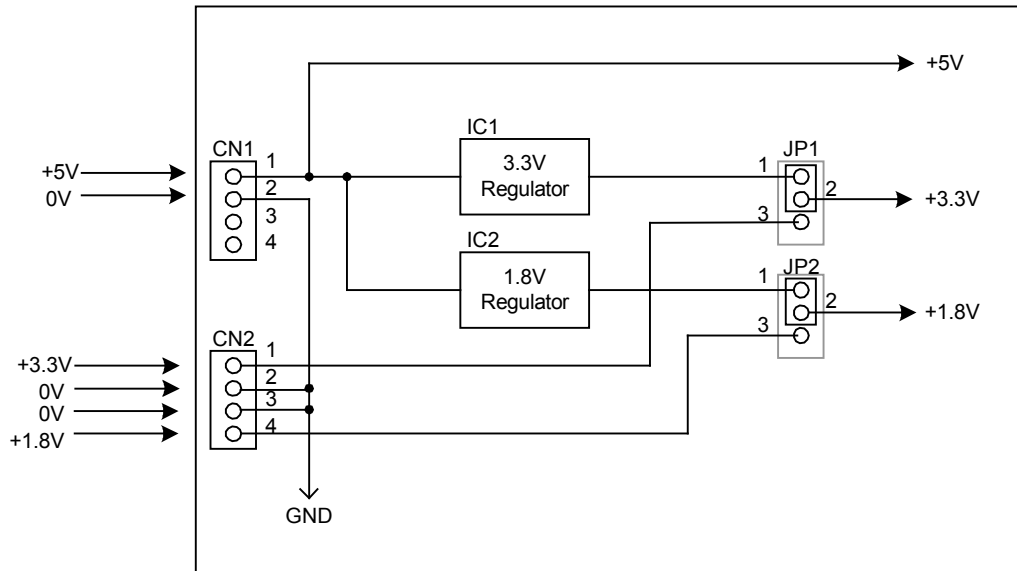



### 3. Function Settings

---

## 3. Function Settings

### 3.1 Jumper pin list

The pin uses and details are as shown below.

 indicates default factory settings.

#### Jumper pin settings

	Use	1–2 shorted	2–3 shorted
JP1	3.3 V power supply selection	Onboard regulator	External input (CN2)
JP2	1.8 V power supply selection	Onboard regulator	External input (CN2)
JP3	LSI 3.3 V consumption current measurement	Always shorted	–
JP4	MODE4 selection	H: For enabled down port setting	L
JP5	MODE3 selection	H: For enabled down port setting	L
JP6	MODE2 selection	H: Individual mode	L: Gang mode
JP7	MODE1 selection	H: VBUS control enabled	L: VBUS control disabled
JP8	MODE0 selection	H: USB1.1 mode	L: USB2.0 mode
JP9	TST0 selection	H: Prohibited	L: Constant

#### Jumper soldering settings

	Use	1–2 shorted	1–3 shorted
JP10	TESTEN selection	L: Constant	H: Prohibited
JP11	PORT4–VBUS supply selection	Onboard VBUS switch	External supply (CN4)
JP12	PORT3–VBUS supply selection	Onboard VBUS switch	External supply (CN4)
JP13	PORT2–VBUS supply selection	Onboard VBUS switch	External supply (CN4)
JP14	PORT1–VBUS supply selection	Onboard VBUS switch	External supply (CN4)

#### 3.2 Mode settings

##### Enabled downstream port setting

Set using MODE[4-3] (JP4 and JP5). All four are enabled with the default factory settings.

MODE4 (JP4)	MODE3 (JP5)	Downstream port			
		D1	D2	D3	D4
L	L	Enabled	Enabled	Disabled	Disabled
L	H	Enabled	Enabled	Enabled	Disabled
H	H	Enabled	Enabled	Enabled	Enabled
H	L	Disabled			

##### VBUS supply mode settings

Set using MODE[2-1] (JP6 and JP7). These are set to “Individual” with the default factory settings.

MODE2 (JP6)	MODE1 (JP7)	JP11 to JP13	JP14	CN4	VBUS supply mode
H	H	1–2 shorted	1–2 shorted	Not connected	Individual mode
L	H	1–3 shorted	1–2–3 all shorted	Connection 1	Gang mode
H/L	L	1–3 shorted	1–3 shorted	Connection 2	Non-control mode

Connection 1: When using in Gang mode, CN4 should also be set as shown below.

The pins shown below as solid circles (pins 3, 6, 9, 12) should be shorted with lead wires.

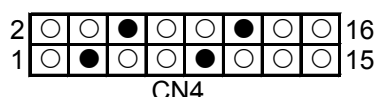

Connection 2: When using in non-control mode, CN4 should also be set as shown below.

The pins shown below as solid circles (pins 3, 6, 9, 12) should be shorted with lead wires and fed with +5 V.

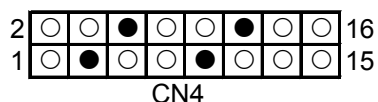

Note: IC8 may be detected as having overcurrent when using in Gang mode, depending on the consumption current of the USB device connected, as IC8 feeds the VBUS for all downstream ports. The initial overcurrent detection setting (R24 = 39 kΩ) is 0.925 A (typ.), and so R24 should be changed appropriately if the total VBUS supply current for all downstream ports exceeds this. For more information, refer to the IC8 data sheet.

##### USB Version mode settings

Set using MODE[0] (JP8). This is set to “USB 2.0 mode” (High Speed) with the default factory settings.

MODE0 (JP8)	USB Version mode
H	USB1.1 (Full Speed)
L	USB2.0 (High Speed)

#### 4. S2R72A43/S2R72A42

---

#### 4. S2R72A43/S2R72A42

S2R72A43 or S2R72A42 can be used as shown below if they are mounted in place of S2R72A44 for IC4.

When using S2R72A43

Pin not connected on IC4	Evaluation board configuration
35pin:D4_VBUSEN	R9 not mounted and CN4 pin 1 not used
28pin:D4_VBUSFLG	R10 not mounted and CN4 pin 2 not used
21pin:D4_DP	CN5 not used
20pin:D4_DM	CN5 not used

When using S2R72A42

Pin not connected on IC4	Evaluation board configuration
35pin:D4_VBUSEN	R9 not mounted and CN4 pin 1 not used
28pin:D4_VBUSFLG	R10 not mounted and CN4 pin 2 not used
21pin:D4_DP	CN5 not used
20pin:D4_DM	CN5 not used
34pin:D3_VBUSEN	R11 not mounted and CN4 pin 4 not used
27pin:D3_VBUSFLG	R12 not mounted and CN4 pin 5 not used
18pin:D3_DP	CN6 not used
17pin:D3_DM	CN6 not used

## 5. Appendix

### 5.1 External dimension diagram

Included at the end of the document.

### 5.2 Circuit diagram

Included at the end of the document.

## 5. Appendix

### 5.3 Parts list

partName	Quantity	Maker	value	rating	tolerance	reference
GCM31CR71C106KA49B	4	Murata	10u	16V	-100	C1,C3,C29,C31
GCM188R11H104KA42B	9	Murata	0.1u	50V	-100	C2,C4,C30,C10
						C32,C11,C12,C13,C14
GCM21BR11E105KA42B	1	Murata	1u	25V	-100	C5
GCM188R11E223KA01B	2	Murata	0.022u	50V	-100	C6,C9
GRM1885C1H7R0DZ01D	2	Murata	7p	50V	+0.5p/-0.5p	C7,C8
GCM188C71A105KA40B	4	Murata	1u	10V	-100	C21,C22,C23,C24
GRM188F11H103ZA01	6	Murata	0.01u	50V	+80/-20%	C15,C16,C17,C18,C19
						C20
GRM188B31A225KE33	3	Murata	2.2u	10V	10%	C10,C11,C14
GRM21BB10J106KE01B	1	Murata	10u	6.3V	10%	C20
EEEHD1C221AP	4	Panasonic	220u	16V	-100	C25,C26,C27,C28
171825-4	1	AMP				CN1
WL-1-4	1	Mac8				CN2
DUSB-BRA42-T11-FA	1	Daiichi-Denshi				CN3
WLW-8-8PW	1	Mac8				CN4
DUSB-ARA42-T11A-FA	4	Daiichi-Denshi				CN5,CN6,CN7,CN8
FA-23A(12MHz)	1	EPSON_QD				CR1
HRW0202B	1	Renesas				DM1
R1170H331B	1	RICOH				IC1
R1130H181B	1	RICOH				IC2
S-80927CNNB	1	SII				IC3
S2R72A04	1	EPSON				IC4
MAX8586ETA+	4	Maxim				IC5,IC6,IC7,IC8
WL-1-2	1	Mac8				JP3
WL-1-3	8	Mac8				JP1,JP2,JP4,JP5, JP6,JP7,JP8,JP9
JS-1	9	Mac8				JP15,JP16,JP17, JP18,JP19,JP20, JP21,JP22,JP23
DLW21SN900SQ2L	5	Murata	90			L3,L4,L5,L6,L7
BLM21PG600SN1	10	Murata	60			L1,L2,L8,L9,L10, L11,L12,L13,L14, L15
SML-512PW(A)	5	ROHM				LED1,LED2,LED3, LED4,LED5
MCR03EZHZ100	1	ROHM	10	1/16W	5%	R4
MCR03EZHZJ000	20	ROHM	0	1/16W	5%	R2,R3,R5,R6,R9,R10, R11,R12,R13,R14, R15,R16,R17,R18, R21,R22,R25,R26, R27,R28
MCR03EZHZ104	1	ROHM	100k	1/16W	5%	R7
RR0816P-123-D	1	SSM	12k	1/16W	0.50%	R8
MCR03EZHZJ393	4	ROHM	39k	1/16W	5%	R19,R20,R23,R24
MCR03EZHZJ821	5	ROHM	820	1/16W	5%	R1,R29,R30,R31,R32
SKRPABE010	1	ALPS				SW1
LC-33-S-Black	4	Mac8				TP1,TP2,TP3,TP4
LC-33-S-Yellow	1	Mac8				TP5
AVRL161A6R8GBA	10	TDK				ZD1,ZD2,ZD3,ZD4, ZD5,ZD6,ZD7,ZD8, ZD9,ZD10

Note:

- Equivalent products may be mounted.
- Includes components not mounted. Check the “No Mount” indication in the circuit diagram.
- Recommend CR1 is amended from FA-23A to FA-238A. Please see “S2R72A04x/4x Series Application Note”.

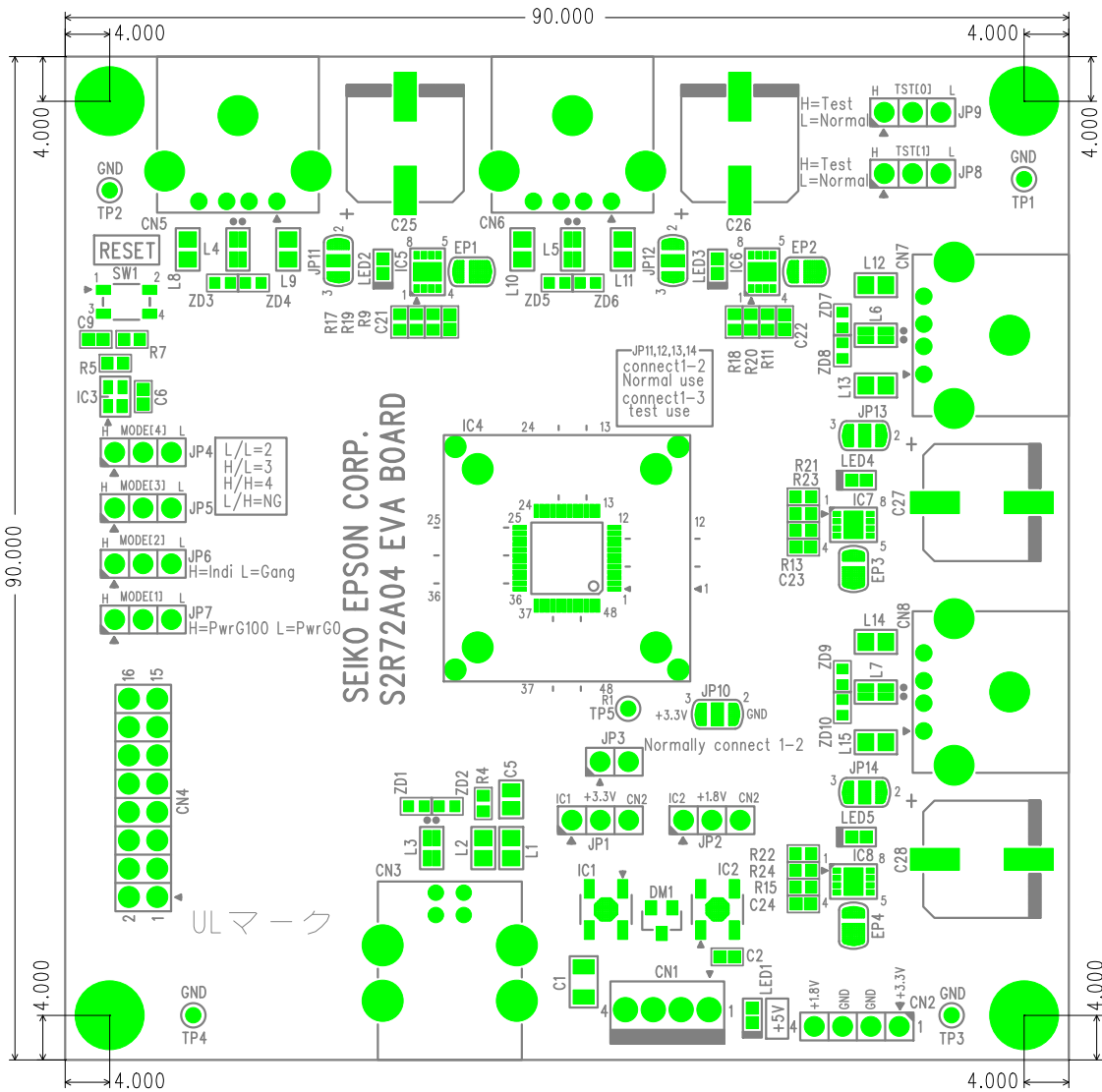

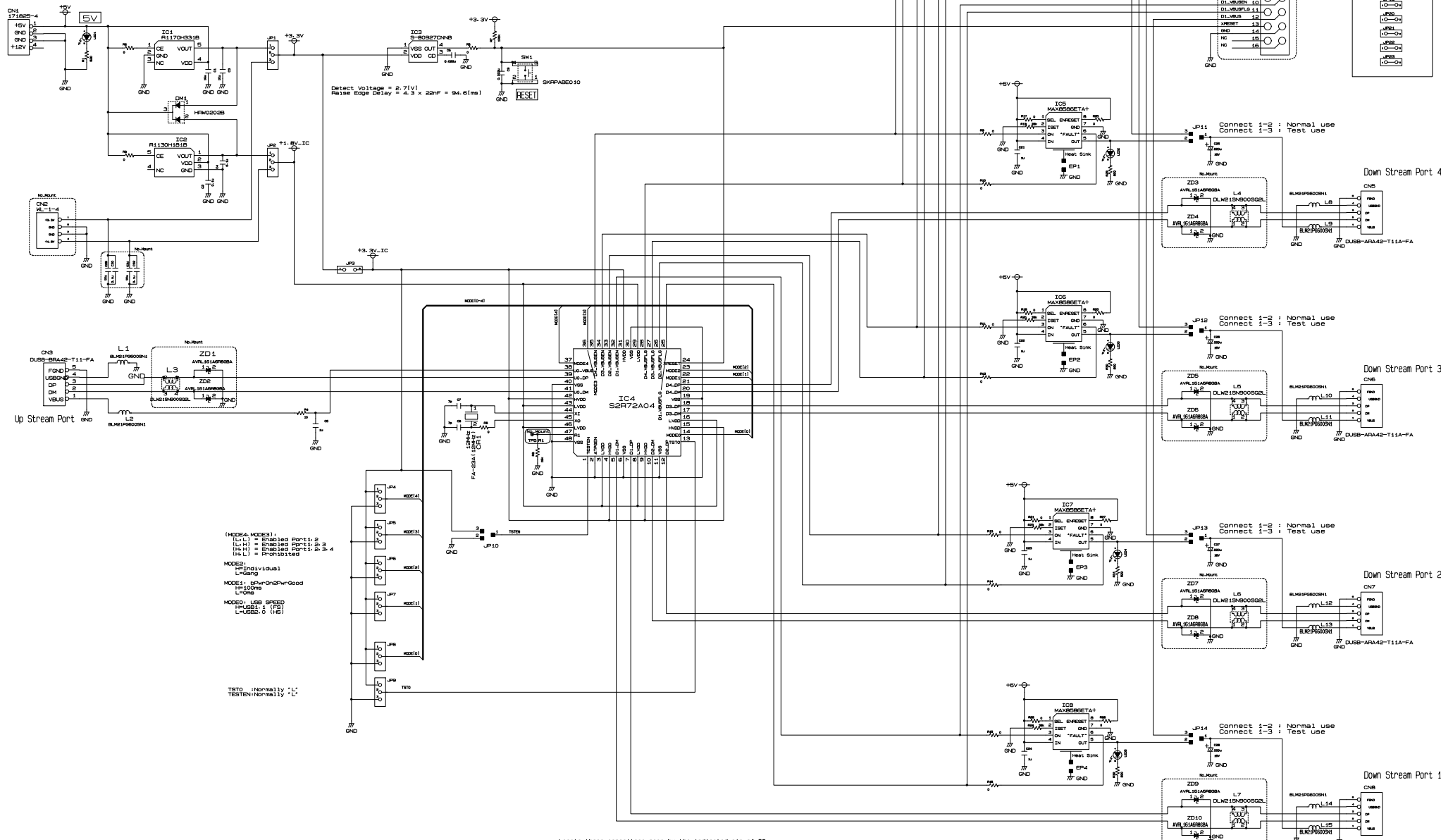

下記部品は、付属品扱い。

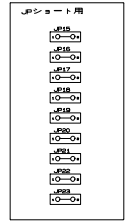

(MODE4, MODE3)  
 [L1] = Disabled Port1,2,3  
 [L2] = Disabled Port1,2,3,4  
 [L3] = Disabled Port1,2,3,4  
 [L4] = Disabled Port1,2,3,4  
 [L5] = Disabled Port1,2,3,4

MODE1: 1pinOn,2pinGood  
 MODE2: 1pinOn,2pinGood  
 MODE3: 1pinOn,2pinGood  
 MODE4: 1pinOn,2pinGood  
 MODE5: 1pinOn,2pinGood  
 MODE6: 1pinOn,2pinGood  
 MODE7: 1pinOn,2pinGood  
 MODE8: 1pinOn,2pinGood  
 MODE9: 1pinOn,2pinGood  
 MODE10: 1pinOn,2pinGood  
 MODE11: 1pinOn,2pinGood  
 MODE12: 1pinOn,2pinGood  
 MODE13: 1pinOn,2pinGood  
 MODE14: 1pinOn,2pinGood  
 MODE15: 1pinOn,2pinGood  
 MODE16: 1pinOn,2pinGood  
 MODE17: 1pinOn,2pinGood  
 MODE18: 1pinOn,2pinGood  
 MODE19: 1pinOn,2pinGood  
 MODE20: 1pinOn,2pinGood  
 MODE21: 1pinOn,2pinGood  
 MODE22: 1pinOn,2pinGood  
 MODE23: 1pinOn,2pinGood  
 MODE24: 1pinOn,2pinGood  
 MODE25: 1pinOn,2pinGood  
 MODE26: 1pinOn,2pinGood  
 MODE27: 1pinOn,2pinGood  
 MODE28: 1pinOn,2pinGood  
 MODE29: 1pinOn,2pinGood  
 MODE30: 1pinOn,2pinGood  
 MODE31: 1pinOn,2pinGood  
 MODE32: 1pinOn,2pinGood  
 MODE33: 1pinOn,2pinGood  
 MODE34: 1pinOn,2pinGood  
 MODE35: 1pinOn,2pinGood  
 MODE36: 1pinOn,2pinGood  
 MODE37: 1pinOn,2pinGood  
 MODE38: 1pinOn,2pinGood  
 MODE39: 1pinOn,2pinGood  
 MODE40: 1pinOn,2pinGood  
 MODE41: 1pinOn,2pinGood  
 MODE42: 1pinOn,2pinGood  
 MODE43: 1pinOn,2pinGood  
 MODE44: 1pinOn,2pinGood  
 MODE45: 1pinOn,2pinGood  
 MODE46: 1pinOn,2pinGood  
 MODE47: 1pinOn,2pinGood  
 MODE48: 1pinOn,2pinGood  
 MODE49: 1pinOn,2pinGood  
 MODE50: 1pinOn,2pinGood  
 MODE51: 1pinOn,2pinGood  
 MODE52: 1pinOn,2pinGood  
 MODE53: 1pinOn,2pinGood  
 MODE54: 1pinOn,2pinGood  
 MODE55: 1pinOn,2pinGood  
 MODE56: 1pinOn,2pinGood  
 MODE57: 1pinOn,2pinGood  
 MODE58: 1pinOn,2pinGood  
 MODE59: 1pinOn,2pinGood  
 MODE60: 1pinOn,2pinGood  
 MODE61: 1pinOn,2pinGood  
 MODE62: 1pinOn,2pinGood  
 MODE63: 1pinOn,2pinGood  
 MODE64: 1pinOn,2pinGood  
 MODE65: 1pinOn,2pinGood  
 MODE66: 1pinOn,2pinGood  
 MODE67: 1pinOn,2pinGood  
 MODE68: 1pinOn,2pinGood  
 MODE69: 1pinOn,2pinGood  
 MODE70: 1pinOn,2pinGood  
 MODE71: 1pinOn,2pinGood  
 MODE72: 1pinOn,2pinGood  
 MODE73: 1pinOn,2pinGood  
 MODE74: 1pinOn,2pinGood  
 MODE75: 1pinOn,2pinGood  
 MODE76: 1pinOn,2pinGood  
 MODE77: 1pinOn,2pinGood  
 MODE78: 1pinOn,2pinGood  
 MODE79: 1pinOn,2pinGood  
 MODE80: 1pinOn,2pinGood  
 MODE81: 1pinOn,2pinGood  
 MODE82: 1pinOn,2pinGood  
 MODE83: 1pinOn,2pinGood  
 MODE84: 1pinOn,2pinGood  
 MODE85: 1pinOn,2pinGood  
 MODE86: 1pinOn,2pinGood  
 MODE87: 1pinOn,2pinGood  
 MODE88: 1pinOn,2pinGood  
 MODE89: 1pinOn,2pinGood  
 MODE90: 1pinOn,2pinGood  
 MODE91: 1pinOn,2pinGood  
 MODE92: 1pinOn,2pinGood  
 MODE93: 1pinOn,2pinGood  
 MODE94: 1pinOn,2pinGood  
 MODE95: 1pinOn,2pinGood  
 MODE96: 1pinOn,2pinGood  
 MODE97: 1pinOn,2pinGood  
 MODE98: 1pinOn,2pinGood  
 MODE99: 1pinOn,2pinGood  
 MODE100: 1pinOn,2pinGood

TEST0: Normally 'L'  
 TEST1: Normally 'L'

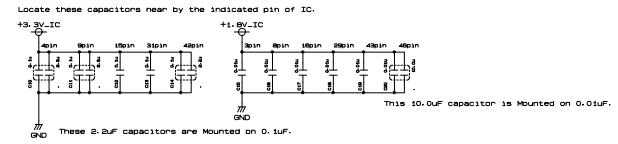

品名	数量	単位	備考
S2P72A04 EVA BOARD	1	個	
M310	1	個	
L1 (Rev.1.2)	1	個	
2010/12/09			

Revision History

Attachment-1

Rev. No.	Date	Page	Type	Revision details (including previous details) and reason
Rev. 1.00	08/05/2009	All	New	New issue
Rev. 1.10	03/15/2010	P.7 P.9	Correction	Capacitor Value for IC4, XAL are modified.
Rev 1.20	12/07/2010	Title	Correction	Before: "S2R72A04 Evaluation Board Manual" After: "S2R72A Series LSI Evaluation Board Manual"
Rev 1.20	12/07/2010	Scope	Add	Add Product Code
Rev 1.20	12/07/2010	P.5	Correction	Before: "S2R72A04", "S2R72A03", "S2R72A02" After: "S2R72A44", "S2R72A43", "S2R72A42"
Rev 1.20	12/07/2010	P.7 P.9	Correction	Capacitor (C20) Value for LVDD is modified. Before: 0.01uF + 4.7uF After: 0.01uF + 10.0uF
Rev 1.30	10/01/2015	P.8	Add	Recommended CR1 is amended from FA-23A to FA-238A.



### AMERICA

---

**EPSON ELECTRONICS AMERICA, INC.**

2580 Orchard Parkway,  
San Jose, CA 95131, USA  
Phone: +1-800-228-3964      FAX: +1-408-922-0238

### EUROPE

---

**EPSON EUROPE ELECTRONICS GmbH**

Riesstrasse 15, 80992 Munich,  
GERMANY  
Phone: +49-89-14005-0      FAX: +49-89-14005-110

### ASIA

---

**EPSON (CHINA) CO., LTD.**

7F, Jinbao Bldg., No.89 Jinbao St.,  
Dongcheng District,  
Beijing 100005, CHINA  
Phone: +86-10-6410-6655      FAX: +86-10-6410-7320

**SHANGHAI BRANCH**

7F, Block B, Hi-Tech Bldg., 900 Yishan Road,  
Shanghai 200233, CHINA  
Phone: +86-21-5423-5522      FAX: +86-21-5423-5512

**SHENZHEN BRANCH**

12F, Dawning Mansion, Keji South 12th Road,  
Hi-Tech Park, Shenzhen 518057, CHINA  
Phone: +86-755-2699-3828      FAX: +86-755-2699-3838

**EPSON TAIWAN TECHNOLOGY & TRADING LTD.**

14F, No. 7, Song Ren Road,  
Taipei 110, TAIWAN  
Phone: +886-2-8786-6688      FAX: +886-2-8786-6660

**EPSON SINGAPORE PTE., LTD.**

1 HarbourFront Place,  
#03-02 HarbourFront Tower One, Singapore 098633  
Phone: +65-6586-5500      FAX: +65-6271-3182

**SEIKO EPSON CORP.****KOREA OFFICE**

50F, KLI 63 Bldg., 60 Yoido-dong,  
Youngdeungpo-Ku, Seoul 150-763, KOREA  
Phone: +82-2-784-6027      FAX: +82-2-767-3677

---

**SEIKO EPSON CORP.****SEMICONDUCTOR OPERATIONS DIVISION****IC Sales Dept.****IC International Sales Group**

421-8, Hino, Hino-shi, Tokyo 191-8501, JAPAN  
Phone: +81-42-587-5814      FAX: +81-42-587-5117